

READ ALL INSTRUCTIONS COMPLETELY AND THOROUGHLY UNDERSTAND THEM BEFORE DOING ANYTHING.
CALL CHASSISWORKS TECH SUPPORT (916) 388-0288 IF YOU NEED ASSISTANCE.

INSTALLATION GUIDE



5813-M10

Billet g-Link Canted 4-Bar Coil-Over Rear Suspension 1964-1966 Mustang



Description: Canted 4-bar coil-over rear suspension for 1964-1966 Mustangs. Includes upper links, lower links, suspension cradle, axle brackets, shocks and springs

Note: Installation requires welding

Figure 2-1

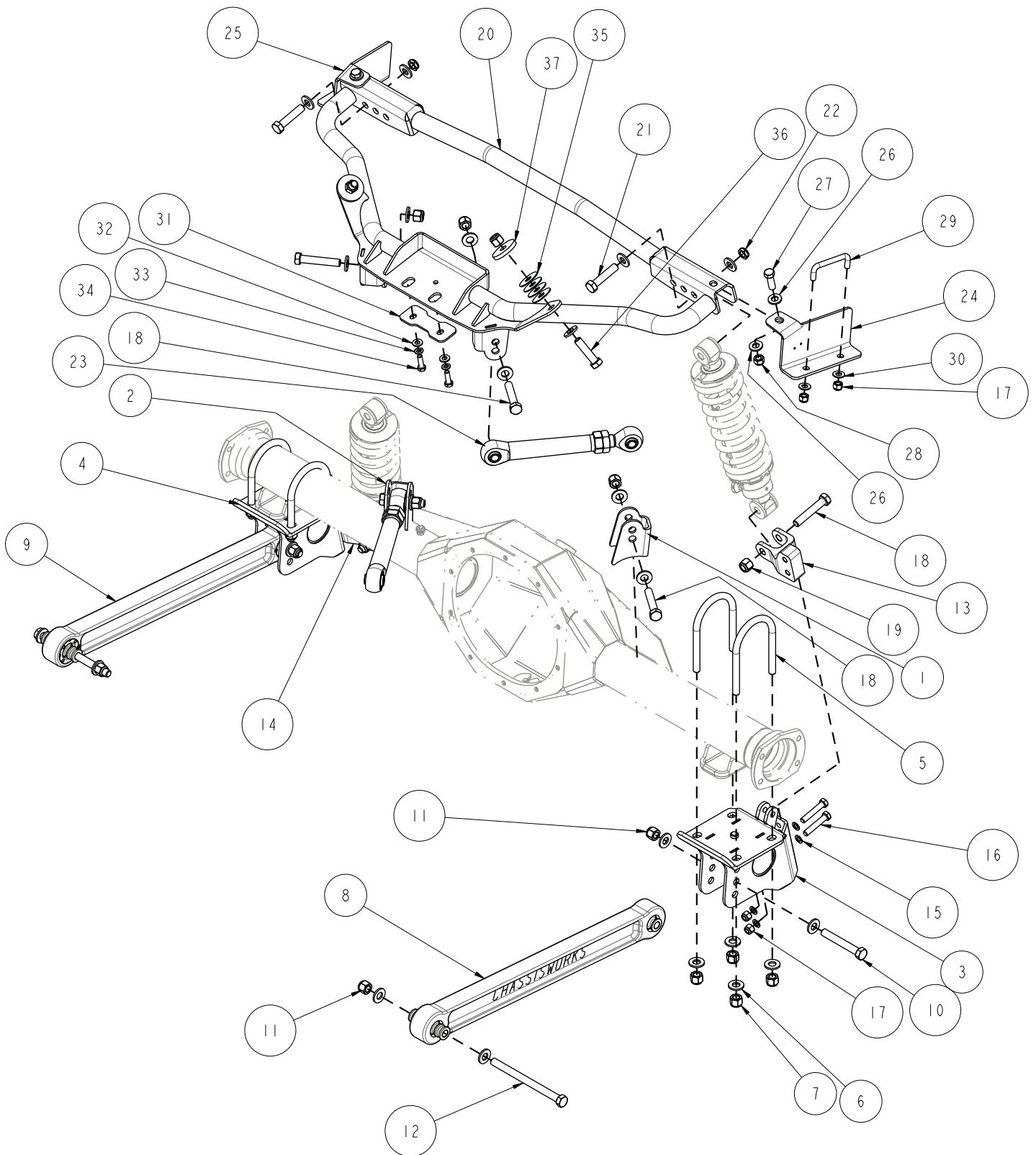

ITEM	QTY	PART NO.	DESCRIPTION
1	1	230229	UCA AXLE BRACKET, DRIVER G-BAR, 64-70 MUSTANG
2	1	230230	UCA AXLE BRACKET, PSGR G-BAR, 64-70 MUSTANG
3	1	5336	LOWER LINK MOUNT, DRIVER, G-BAR REAR STYLE A-ROLL BAR, 64-70 MUSTANG
4	1	5337	LOWER LINK MOUNT, PSGR, G-BAR REAR STYLE A-ROLL BAR, 64-70 MUSTANG
5	4	3147-300.50-500	U-BOLT, AXLE TUBE, 1/2-20 x 3.00 x 5.00
6	30	3120-050S-Y	FLAT WASHER, 1/2 SAE, HARDENED
7	8	3131-050-20Y	LOCKNUT 1/2-20, GRADE 8, NYLON INSERT, YELLOW ZINC
8	1	3811-21.00-ADD	LOWER CONTROL ARM ASSEMBLY, DRIVER, G-BAR, 21 LONG, BILLET 4-LINK
9	1	3811-21.00-ADP	LOWER CONTROL ARM ASSEMBLY, PSGR, G-BAR, 21 LONG, BILLET 4-LINK
10	2	3100-050C3.50Y	HEX BOLT, 1/2-13 x 3 1/2, GRADE 8, YELLOW ZINC
11	4	3101-050-13C	LOCKNUT 1/2-13, GRADE 5, NYLON INSERT, CLEAR ZINC
12	2	3100-050C6.50Y	HEX BOLT, 1/2-13 x 6 1/2, GRADE 8, YELLOW ZINC
13	1	1477D	G-BAR STRAIGHT SHOCK MOUNT, DRIVER, ADJUSTABLE, OFFSET
14	1	1477P	G-BAR STRAIGHT SHOCK MOUNT, PSGR, ADJUSTABLE, OFFSET
15	8	3109-038-S-2-Y	AIRCRAFT WASHER 3/8 x .062 THICK
16	4	3128	HEX BOLT, 3/8-24 x 2, GRADE 8, YELLOW ZINC
17	8	3101-038-24C	LOCKNUT, 3/8-24, GRADE 8, NYLON INSERT, CLEAR ZINC
18	6	3107	BOLT, 1/2-20 x 2 3/4 HEX CAP
19	8	3101-050-20C	LOCKNUT, 1/2-20, GRADE 8, NYLON INSERT, CLEAR ZINC
20	1	5150	G-BAR FRAME WELDMENT, 64-66 MUSTANG
21	2	3100	HEX BOLT, 1/2-20 x 2 1/4 HEX CAP SCREW, GRADE 8, YELLOW ZINC
22	2	3117-050-20C	LOCKNUT, 1/2-20, GRADE 8, HALF HEIGHT, NYLON INSERT, CLEAR ZINC
23	2	3814-09.50	G-LINK UPPER LINK ASSY, BALL PIVOT, 9.50 CENTER LENGTH
24	1	5349	FRAME BRACKET WELDMENT, DRIVER, G-BAR, 64-70 MUSTANG
25	1	5350	FRAME BRACKET WELDMENT, PSGR, G-BAR, 64-70 MUSTANG
26	4	3120-044S-Y	FLAT WASHER, 7/16 SAE, HARDENED
27	2	3100-044-C1.25Y	HEX CAP SCREW 7/16-14 x 1 1/4
28	2	3101-044-14C	LOCKNUT 7/16-14, GRADE 5 NYLON INSERT, CLEAR ZINC
29	2	3148-263.38-088	SQUARE BEND U-BOLT, 3/8-24 x 2.625 x .875
30	4	3120-038S-Y	FLAT WASHER, 3/8 SAE, HARDENED
31	1	210110	WASHER PLATE, GBAR SNUBBER MOUNT, 64-70 MUSTANG
32	2	3120-031S-Y	FLAT WASHER, 5/16 SAE, HARDENED
33	2	3108-031L-C	LOCK WASHER, HELICAL SPRING Ø5/16, STEEL, ZINC
34	2	3100-031C1.00Y	HEX CAP SCREW 5/16-18 x 1, GRADE 8, YELLOW ZINC
35	8	2071	SHIM, SHOCK TAB, G-BAR FRAME, 64-70 MUSTANG
36	2	3102	HEX BOLT, 1/2-20 x 2, GRADE 8, YELLOW ZINC
37	2	2128	WASHER Ø.50 x Ø1.85 x .25 THICK

**G-BAR 64-66 MUSTANG, BILLET CONTROL ARMS,
REAR SUSPENSION PACKAGE**

Chris Alston's **CHASSISWORKS INC.**
8661 YOUNGER CREEK DRIVE
SACRAMENTO, CA 95828
(916) 388-0288 FAX 388-0295

PART NO.

5813-M10

9/11/07

DWG: 915813-M10

PARTS LIST

Prior to beginning installation use the following parts lists to verify that you have received all components required for installation.

Lower Suspension Links - 300-0103 (billet pivot)

Qty	Part Number	Description
1	3811-21.00-ADD	Billet g-Link dual pivot-ball lower link assembly 21" long, driver-side
1	3811-21.00-ADP	Billet g-Link dual pivot-ball lower link assembly 21" long, passenger-side
2	3100-050C3.50Y	Bolt, 1/2-13 x 3-1/2" hex head Grade 8
2	3100-050C4.75Y	Bolt, 1/2-13 x 4-3/4" hex head Grade 8 (NOT USED)
2	3100-050C6.50Y	Bolt, 1/2-13 x 6-1/2" hex head Grade 8
4	3101-050-13C	Locknut, 1/2-13 nylon insert
8	3120-050S-Y	Washer, 1/2" hardened flat SAE
OPTION	Offset billet g-Link dual pivot-ball lower link assemblies 21" long (increased wheel clearance)	

Upper Suspension Links - 300-0105 (pivot)

Qty	Part Number	Description
2	3814-09.50	g-Link dual pivot-ball billet upper link assembly, 9-1/2" long
4	3101-050-20C	Locknut, 1/2-20 nylon insert
4	3100-050F2.75Y	Bolt, 1/2-20 x 2-3/4" hex head Grade 8
8	3120-050S-Y	Washer, 1/2" hardened flat SAE
OPTION	Double-adjustable g-Link pivot-ball upper links, 9-1/2" long (increased pinion angle adjustment)	

Lower Shock Mounts - 300-0106

Qty	Part Number	Description
1	1477-D	Shock mount, billet aluminum, driver side
1	1477-P	Shock mount, billet aluminum, passenger side
4	3101-038-24C	Locknut, 3/8-24 nylon insert
2	3101-050-20C	Locknut, 1/2-20 nylon insert
2	3100-050F2.75Y	Bolt, 1/2-20 x 2-3/4" hex head Grade 8
8	3109-038-S-2-Y	Aircraft washer, 3/8" small OD
4	3100-038F2.00Y	Bolt, 3/8-24 x 2" hex head Grade 8

Axle Mounts - 300-0107* (for factory housing with sliding-link or no anti-roll bar)

Qty	Part Number	Description
1	230229	Upper axle bracket, driver side
1	230230	Upper axle bracket, passenger side
1	5336	Lower axle bracket with endlink mount, driver side
1	5337	Lower axle bracket with endlink mount, passenger side
8	3120-050S-Y	Washer, 1/2" hardened flat SAE
8	3131-050-20Y	Locknut, 1/2-20 nylon insert, Grade 8
4	3147-300.50-500	U-bolt, round 1/2-20 x 5" long x 3" ID

Notes:

* Package omitted with selection of direct-fit FAB9™ housing or splined-end anti-roll bar.

Axle Mounts - 300-0108* (for factory housing with splined-end anti-roll bar)

Qty	Part Number	Description
1	230229	Upper axle bracket, driver side
1	230230	Upper axle bracket, passenger side
1	5338	Lower axle bracket with anti-roll bar mount, driver side
1	5339	Lower axle bracket with anti-roll bar mount, passenger side
8	3120-050S-Y	Washer, 1/2" hardened flat SAE
8	3131-050-20Y	Locknut, 1/2-20 nylon insert, Grade 8
4	3147-300.50-500	U-bolt, round 1/2-20 x 5" long x 3" ID
Notes:		
*	Package omitted with selection of direct-fit FAB9™ housing, or sliding-link or no anti-roll bar.	

g-Bar Cradle and Hardware - 300-0109

Qty	Part Number	Description
1	5150	g-Bar cradle weld assembly, 1964-66 Mustang
8	2071	Shim, 1-1/2" OD x 1/2" ID x 1/16" thick, clear zinc
1	210110	Washer plate, snubber mount, clear zinc
2	2128	Washer, .50 x 1.85 x .25" thick, clear zinc
2	3100-050F2.25Y	Bolt, 1/2-20 x 2-1/4" hex head, Grade 8
2	3100-031C1.00Y	Bolt, 5/16-18 x 1" hex head
2	3101-050-20C	Locknut, 1/2-20 nylon insert
2	3100-050-F2.00Y	Bolt, 1/2-20 x 2" hex head
2	3108-031L-C	Lock washer, 5/16" regular
2	3117-050-20C	Locknut, 1/2-20 nylon insert, half height
2	3120-031S-Y	Washer, 5/16" hardened flat SAE
6	3120-050S-Y	Washer, 1/2" hardened flat SAE

Frame Mounts and Hardware - 300-0111 (for splined-end or no anti-roll bar)

Qty	Part Number	Description
1	5349	Frame bracket weldment, driver side
1	5350	Frame bracket weldment, passenger side
2	3100-044C1.25Y	Bolt, 7/16-14 x 1-1/4" hex head
4	3101-038-24C	Locknut, 3/8-24 nylon insert
2	3101-044-14C	Locknut, 7/16-14 nylon insert
4	3120-038S-Y	Washer, 3/8" hardened flat SAE
4	3120-044S-Y	Washer, 7/16" hardened flat SAE
2	3148-263.38-094	U-bolt, square 3/8-24 x 2-5/8" wide x 15/16" long

Frame Mounts and Hardware - 300-0112 (for sliding-link anti-roll bar)

Qty	Part Number	Description
1	5345	Frame bracket weldment with anti-roll bar mount, driver side
1	5346	Frame bracket weldment with anti-roll bar mount, passenger side
2	3100-044C1.25Y	Bolt, 7/16-14 x 1-1/4 hex head
4	3101-038-24C	Locknut, 3/8-24 nylon insert
2	3101-044-14C	Locknut, 7/16-14 nylon insert
4	3120-038S-Y	Washer, 3/8 hardened flat SAE
4	3120-044S-Y	Washer, 7/16 hardened flat SAE
2	3148-263.38-094	U-bolt, square 3/8-24 x 2-5/8 wide x 15/16 long

Shock Absorber Components

Qty	Part Number	Description
1 (pair)	VAS 11X11-515	VariShock coil-over QuickSet 1, 5.15 travel, 16.10 extended, spherical bearing ends (QuickSet 2 optional)
1 (pair)	VAS 21-12XXX	VariSprings 12" long (spring rate optional)
1	VAS 508-100	Shock mount spacer set

The g-Link Canted 4-Bar Rear Coil-Over Kit replaces the majority of components in your existing rear suspension. It is necessary to remove all of the existing components to prepare for installation.

INSTRUCTIONS

1. Before starting measure the height of the rear wheel well opening from the ground on the driver and passenger sides. Record these dimensions.

This measurement will be used as a reference to adjust the height of the lower billet shock mount and verify that the ride height is set correctly.

2. Measure from the center of the axle to the fender lip. Record these measurements.

It may be easier to accurately measure from the center of the axle to the ground. This measurement can be subtracted from the previous fender-lip to ground measurement to calculate the needed dimension.



This information provides a reference point to correctly position rear end housing once the vehicle is off the ground and the wheels are removed. Usually the vehicle ride height is kept at stock or slightly lower. Depending upon the choice of rear wheel and tire, the axle height may be modified.

3. Raise vehicle to a safe and comfortable working height. Use jack stands or a two-post lift to support the vehicle with suspension hanging freely. Make sure it is level front to rear and right to left.
4. Remove any portions of exhaust system that may interfere with installation. Mufflers in the stock location can remain in place. Unbolt or cut any exhaust tubing that is routed over the rear end housing.
5. Disconnect the driveshaft and brake lines from the rearend housing. Brake and fuel lines can remain on vehicle but will need to be secured along the body to prevent damage during installation.
6. Place a floor jack underneath the rearend center section to support its weight as the rear suspension is removed as an assembly.
7. Unbolt the front leaf-spring eyes and rear spring shackles from the vehicle, and removed the rear suspension.



Chassis Inspection

8. With the leaf springs out of the way, inspect the sheet metal for signs of fatigue. Clean the area to remove any grease or dirt so the metal and welds are clearly visible. Look for cracks along the welds or tearing of the mounts in any way. If there is any damage present, repairs will have to be made before proceeding.
9. **The area around the factory pinion snubber mount is critical to providing a stable and durable mounting location for the g-Bar cradle and must be welded prior to beginning installation.**



Moderate Street Performance:

At a minimum the sheet metal seams around the pinion snubber mount and along the leading edge of the factory shock crossmember must be ground to bare metal and stitch welded to provide additional support for the factory spot welds.



High Horsepower and Traction:

Vehicles equipped with racing slicks, drag-radials, or wide street tires (mini-tubed) must tie the upper-control-arm mounting area of the g-Bar cradle to the roll cage or a fabricated structural crossmember. The combination of high-horsepower and available traction will damage the sheet metal if necessary precautions are not taken.

10. Prior to welding, use a hammer to flatten the factory seams.

IMPORTANT: The rear seat must be removed before welding. The lower seam weld is along the interior panel and will ignite any material that has not been cleared from this area.

11. Allow the welds to cool, then paint to protect the metal from rust.
12. Prepare the frame rail brackets for welding to chassis by removing the zinc coating along the outside edges, where the welds will be made. Use a drill with scotch-brite pad or wire wheel attachment.



13. Loosely bolt the driver and passenger frame brackets to the cradle using the 7/16" bolts, flat washers and locknuts provided. The cradle holes are slotted and the brackets left loose to allow the cradle to properly fit vehicles with variances at the frame rails.



14. Position the cradle against the vehicle, aligning the cradle tabs with the factory shock mounting holes and the slotted holes at the front of the cradle with the pinion snubber mount.
15. Put the snubber washer plate over the slotted holes on the cradle and secure with the 5/16-18 x 1" bolts and flat washers.



16. Clamp the brackets against the frame rails to hold the cradle up during alignment.



17. With the brackets clamped, a rubber mallet must be used to adjust the cradle's position, if needed.



18. When the cradle is correctly positioned, a small gap between the cradle tab and the factory shock mount surface is normal. Shims are included in the hardware kit and will be installed later.



19. Measure from a chassis reference point, such as the factory shock crossmember, to each bracket to ensure the cradle is positioned square to the chassis.



20. With the cradle in the correct position and the brackets tight against the inside and bottom surfaces of the frame rail, tighten the 7/16" mounting hardware to 40 lb. ft.

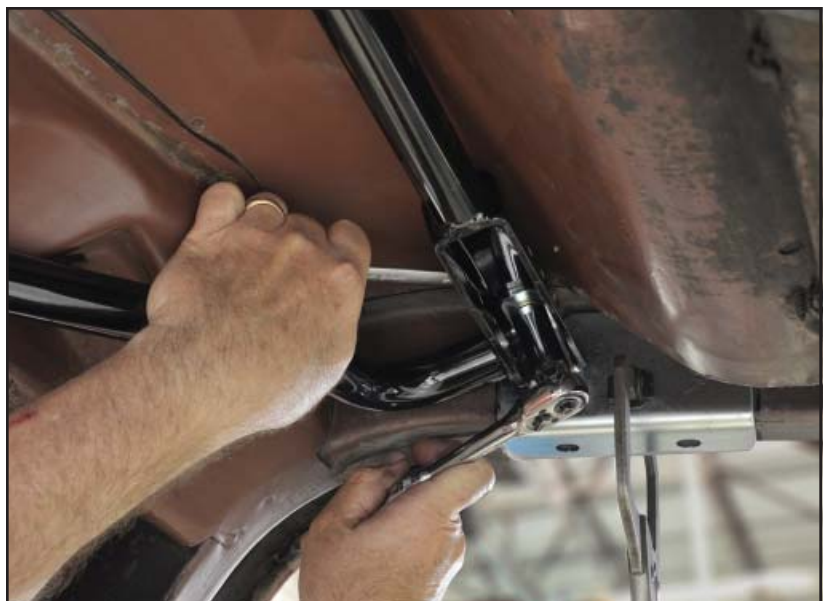

21. Use a marker to trace the outline of the frame brackets. This marked area will be ground to bare metal for welding the bracket to the frame rail.



22. Scribe the bracket's oval holes onto the surface of each frame rail.

NOTE: Any pre-existing holes at these locations will be widened to the shape of the scribed marks.

23. Once both brackets are clearly marked, remove the pinion snubber mount hardware and unclamp the frame brackets.

DO NOT LOOSEN OR SHIFT THE CRADLE BRACKETS.

24. Lower the cradle assembly and set aside.



25. Center punch and drill a "starting hole" through the frame rail at each scribed oval, using a 3/8"-diameter bit.

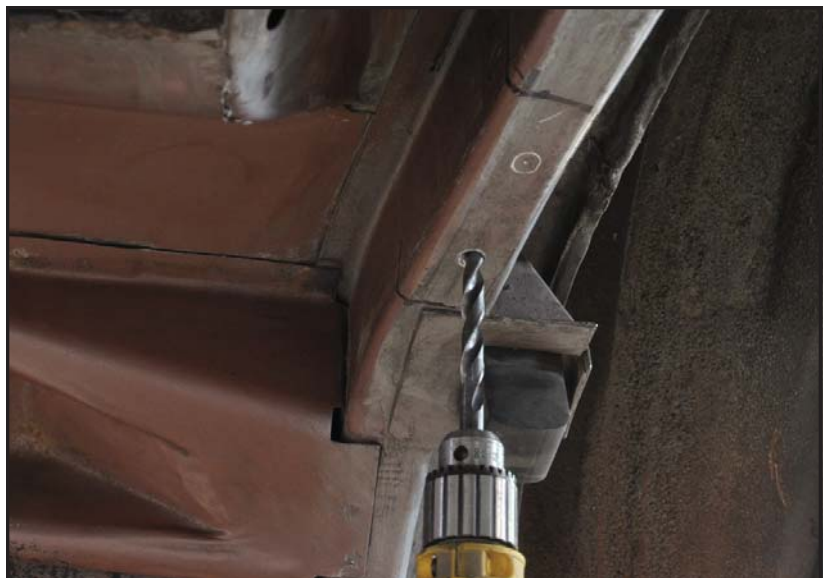

26. Use a die grinder or file to enlarge the holes to the scribed outline.



27. Use a disc sander to expose bare metal along the marked weld line on the frame rail. DO NOT grind into the frame rail. Paint and debris only need to be removed in order to prep a good weld area.



28. Clamp the cradle into the car and align the frame brackets with slotted holes in frame rail.
29. Install the washer plate, pinion snubber, and snubber mounting hardware. Torque to 20 lb-ft.



30. Install enough shims to minimize the gap between the cradle tabs and factory shock mount surface.
31. The 1/2-20 x 2" bolt that secures the cradle tabs and shims must be inserted from underneath the vehicle and secured with a flat washer and locknut from inside the truck.



32. Through the access hole in the truck, slide the 1/4"-thick washer over the bolt and secure with a locknut. Tighten to 70 lb-ft.



33. Install one 3/8" flat washer and locknut onto one end of each square-corner U-bolt to prevent losing the U-bolt inside the frame rail.
34. Insert the other end of the U-bolt into the hole in the frame bracket, and then out through the second hole.
35. Place a 3/8" washer over the stud and secure with a locknut.
36. Once both bolts are in place, evenly tighten the locknuts to 30 lb-ft.



37. Tack weld each bracket to the frame rail.



38. Stitch weld 1" long beads, 1" apart around the complete outside edge of each bracket, including along the top edge.



39. Weld as far up the ends of the brackets as possible, as well as the top of the bracket where it contacts the double layer in the unibody frame rail.

40. Allow the welds to cool, then paint to protect the metal from rust.



Factory Rearend Housings

41. All fluid must be drained and residue removed from housing to reduce risk of fire during welding.
42. All components must be removed including brakes, axles, and third-member.
43. Weld fixture (6716) bolts directly to 9" housings and can be clamped to the face of 8" housings. If clamping the fixture, measure from the housing ends to the fixture to be sure it is center. Refer to installation guide (916716) for specific instructions on using the weld fixture.
44. Position the lower axle brackets onto the rearend-housing spring plates. The powder coating on the alignment pin may have to be removed for the bracket to fully seat.
45. Place the 1/2" U-bolts over the axle tube and through the holes in the axle bracket. Secure with flat washers and locknuts. Tighten evenly to 60 lb-ft.



Chassisworks FAB9™ Housings

Bolt-in FAB9™ rearend housings are available pre-assembled with welded upper and lower control arm brackets. Housings accept Ford 9" third-members and axles. Installation of control arms and anti-roll bars is identical to factory housing installations.



46. Position the rearend housing under the car on jack stands.



47. Adjust the upper suspension links to 9-1/2", measured from the center of each mounting hole.



48. Attach the non-adjustable end of upper links to the lower holes of the cradle with 1/2" bolts, flat washers and locknuts. Grease zerk fittings must point downward. Do not fully tighten at this time.



49. Bolt opposite end of each upper link to the upper hole at the axle bracket. Grease zerk fittings must point upward. Do not fully tighten at this time.



50. Install the lower suspension links at the factory front leaf spring mount using 1/2" diameter bolts, flat washers and locknuts. Grease zerk fittings must point downward. Do not fully tighten at this time.

OPTION: Offset lower arms are available for additional tire clearance.



51. Attach the lower suspension links to the axle brackets with 1/2" bolts, flat washers and locknuts. Use the second hole from the bottom on the axle brackets for initial installation. Torque to 65 lb-ft.

52. Raise and support the rearend housing to the ride-height position that was measured earlier. Measure from the center of the axle to the top of the fender.



53. Slide the billet shock mount into the lower link bracket on the housing. Leave one hole a blank at the bottom and secure the shock mount with the 3/8" bolts, aircraft washers and locknuts supplied. Tighten the bolts to 35 lb-ft.

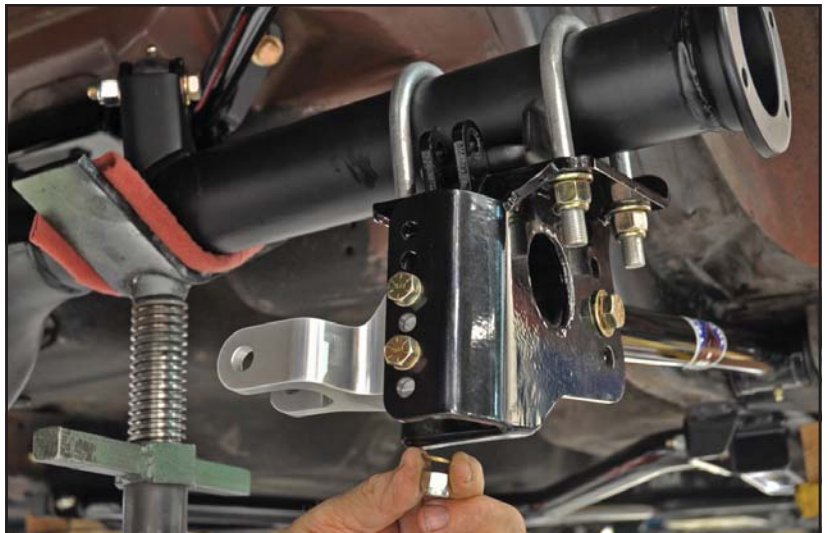

54. Raise the rearend housing so that the distance from the billet shock mount hole to the center upper-shock-mount hole measures 13-1/2". This is the baseline ride-height position
55. Check the axle center to fender lip opening from Step 2. Adjust the billet lower shock mount position to correctly position the axle housing at the original ride height or a different ride height if desired.

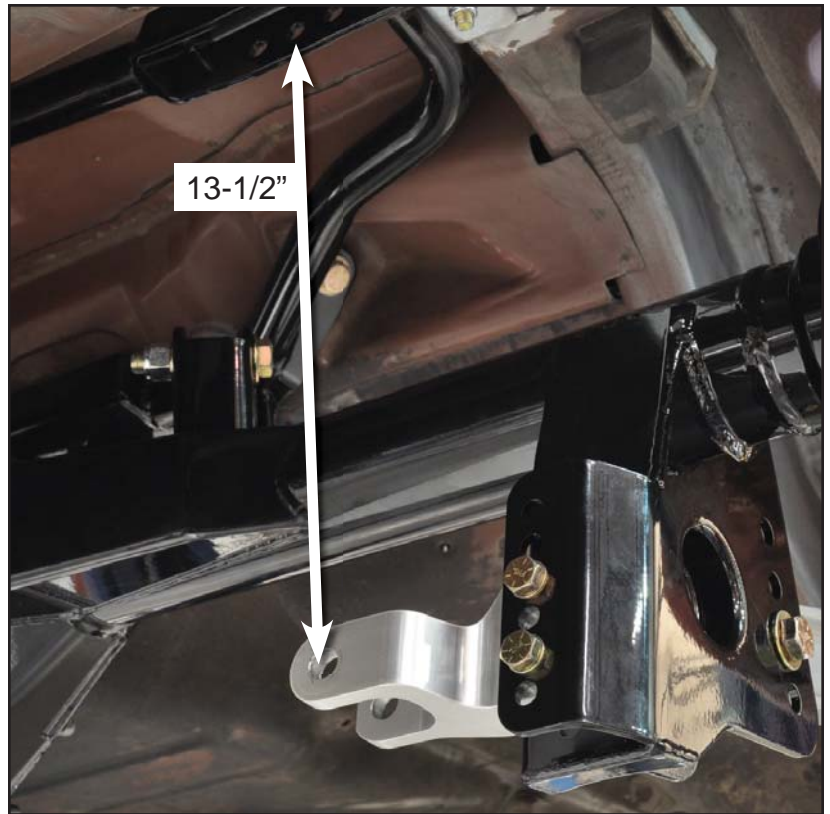

The shocks are initially installed without the coil springs to allow the suspension to be easily moved throughout its range of travel for the purposed of checking clearances and alignment.

56. Place the spacers on each side of the spherical bearing and slide the assembly into the upper shock mount in the cradle. Install the 1/2" bolts, flat washers and half-locknuts from the front to rear as shown.

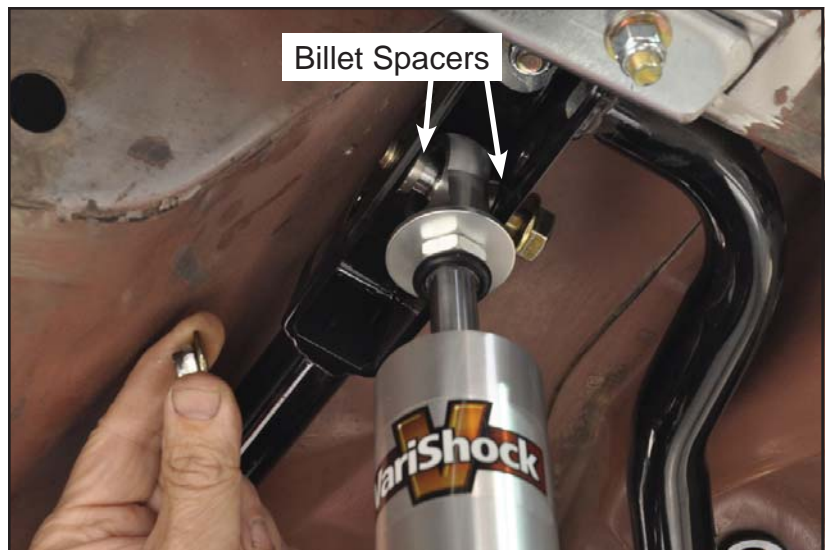

NOTE: Spherical-bearing shocks must use spacer set VAS 508-100. Place one spacer against each side of the bearing for correct fit. The mounting clevis is purposely oversized to also allow use of urethane-bushing shocks.

57. Place the spacers on each side of the spherical bearing and slide the assembly into the billet lower shock mount. Install the 1/2" bolts, flat washers and half-locknuts from the front to rear as shown.



58. Adjust both shocks to their softest setting.
59. Using a jack, cycle rear suspension through its full range of vertical travel and body roll to check for binding and potential clearance issues.
60. Once clearance has been verified, coil springs can be installed onto shocks, then shocks installed onto cradle. Torque hardware to 50 lb-ft.

NOTE: When moving lower shock mounts or suspension link mounting locations the suspension must be checked for binding and adequate clearance throughout its full range of vertical travel and body roll.

61. Refer to coil-over shock and VariSpring installation guides for specific instructions regarding adjusting spring preload and valve adjustment.



Full Compression



Full Extension



Full Roll

62. Reassemble the rearend components and the installation is complete. The upper suspension links can now be used to first center the rearend in relation to the chassis, and then to adjust pinion angle. Lengthening one upper link and shortening the other upper link will move the housing toward the shortened link. Pinion angle is adjusted by shortening or lengthening both links equally. Additional information regarding pinion angle can be found on page 22. Link ends will need to be unbolted from axle brackets to adjust length.

NOTE: Carefully read the Pinion Angle section at the end of this installation guide before determining the correct pinion angle.

Once the adjustments are made tighten the four link bolts to 65 lb-ft.



Mounting Options and Final Adjustments

Lower Suspension Link

Mounting Position: The lower link has three (factory housing) or four (FAB9™ housing) mounting positions at the axle bracket. Ideally, to minimize suspension steering effects (roll steer), the link should be set as close to horizontal as possible with the suspension at ride height. Lowering the rear position from horizontal will also increase available traction, but also increases roll oversteer.

Length (pivot-ball link only): Correct adjusted length is 21.00", measured at the center of the bolt holes. Due to chassis variances it may be necessary to adjust the lower suspension link lengths to position the rear end housing square to the chassis.

Upper Suspension Link

Mounting Position: The upper link has two mounting positions at the cradle bracket and axle bracket. The starting installation position provides the largest anti-squat percentage and provides more immediate traction to the rear tires (less chassis movement). Lowering the front position and/or raising the rear position provides less anti-squat and a more gradual transfer of weight to the rear tires (more chassis movement).

Length: Correct adjusted length is 9.50", measured at the center of the bolt holes. Due to chassis variances it may be necessary to center the housing in relation to the chassis by adjusting the upper suspension link lengths.

Shock Absorber

Lower Mounting Position: The lower shock mount can be moved to one of four positions to alter ride height in 5/8" increments.

Upper Mounting Position: The upper shock mount can be moved to one of three positions along the upper crossmember. Ride height is altered in 1/4" increments at each position with approximately a 5% change in shock/spring stiffness and ride quality. Outermost hole = highest/stiffest; Innermost hole = lowest/softest.

Spring Preload: Refer to VariShock coil-over installation guide (899-031-200 or 899-031-220) for detailed information regarding spring preload and correct balance of travel at ride height.

Under no circumstance should the lower spring seat be used to adjust the shock length at ride-height to less than 13" or more than 14". Damage to the shock absorbers will occur, and you will be charged to repair them.

Maintenance

Suspension Link Lubrication

Each suspension pivot assembly can be lubricated using a standard grease gun. Pivot-ball links without a grease zerk fitting can be lubricated by removing the locking set screw and temporarily installing a zerk fitting.

Pivot-Ball Preload

The retaining ring can be tightened to remove any free-play that develops in the pivot-ball mechanism. Remove the locking set screw and turn the retaining ring clockwise, using a common spanner wrench, to the next set screw position.

Pinion Angle

Understanding Pinion Angle

The often misunderstood pinion angle is simply the angle formed by the centerlines of the driveshaft and rear differential pinion gear where they meet at the rear u-joint. When the pinion angle is set correctly, it is the same angle, but in the opposite direction as the angle formed by the engine-transmission centerline and the driveshaft at the front u-joint (see illustration below). The pinion angle is usually adjusted to match the engine angle as it is easier to change. Contrary to popular opinion, pinion angle is not a tuning aid. Correctly set, it will balance the driveshaft u-joints minimizing vibration and power loss.

Measuring the Drivetrain Angles

A digital protractor or smart level is the best tool to measure the required angles. Engine centerline measurement can be taken from the vertical surface of the transmission tailshaft, the oil pan rail, or the front face of the harmonic balancer. Most production vehicle drive-train angles will run slightly downhill towards the rear bumper. A typical measurement may be 2 to 3 degrees. Driveshaft centerline angles can be measured directly on the shaft tube. Pinion gear centerline angles can be measured on the universal joint yoke or axle housing flange. It is important to be careful how you position the measuring tool so all the angles have the same reference plane. Remember the measurements must be taken with the rear suspension collapsed to the correct ride height.

Adjusting the Third Member Pinion Angle

As an example, a two-degree downhill drivetrain angle would require the third member to be set at two degrees with the snout slightly raised. Pinion angle is set by equally adjusting the upper control arm lengths. Lengthening the arms raises the pinion snout. Upper arm must be unbolted from the axle tabs and jam nut loosened for adjustment. Be sure to tighten the jam nuts and mounting hardware to the torque value specified in this installation guide.

Note: High traction vehicles operated for extended periods at full throttle, such as drag or road racing, may need to compensate for flex in the suspension system by setting the pinion angle an additional 1 to 2 degrees down to avoid drivetrain vibration.

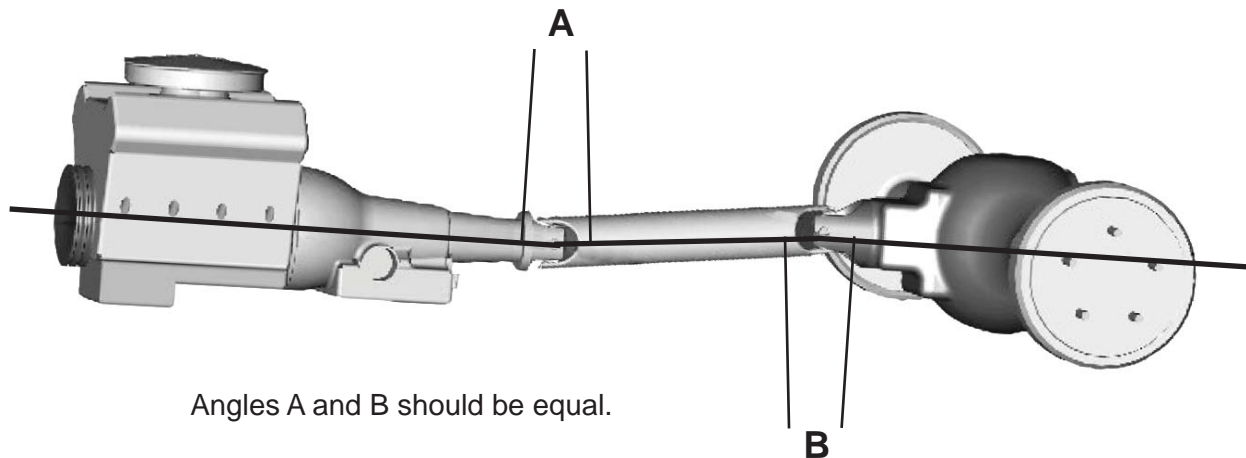

NOTES:

WARRANTY NOTICE:

There are NO WARRANTIES, either expressed or implied. Neither the seller nor manufacturer will be liable for any loss, damage or injury, direct or indirect, arising from the use or inability to determine the appropriate use of any products. Before any attempt at installation, all drawings and/or instruction sheets should be completely reviewed to determine the suitability of the product for its intended use. In this connection, the user assumes all responsibility and risk. We reserve the right to change specification without notice. Further, Chris Alston's Chassisworks, Inc., makes **NO GUARANTEE** in reference to any specific class legality of any component. **ALL PRODUCTS ARE INTENDED FOR RACING AND OFF-ROAD USE AND MAY NOT BE LEGALLY USED ON THE HIGHWAY.** The products offered for sale are true race-car components and, in all cases, require some fabrication skill. **NO PRODUCT OR SERVICE IS DESIGNED OR INTENDED TO PREVENT INJURY OR DEATH.**

Chris Alston's Chassisworks
8661 Younger Creek Drive
Sacramento, CA 95828
Phone: 916-388-0288
Technical Support: tcptech@cachassisworks.com

